

SG500 Series

PV Smart Microinverter

SG500 Series



- Single unit connects to one PV module
- Maximum 500W AC output power
- Single-phase output, Flexible 3-phase PV systems
- WIFI communication and cloud monitoring
- Up to 9 units (230V) per branch
- Customizable various input (DC, PV) voltage range
- Integrated AC bus cable, Ready-To-Use
- Low cost, Easy installation

Basic Structure

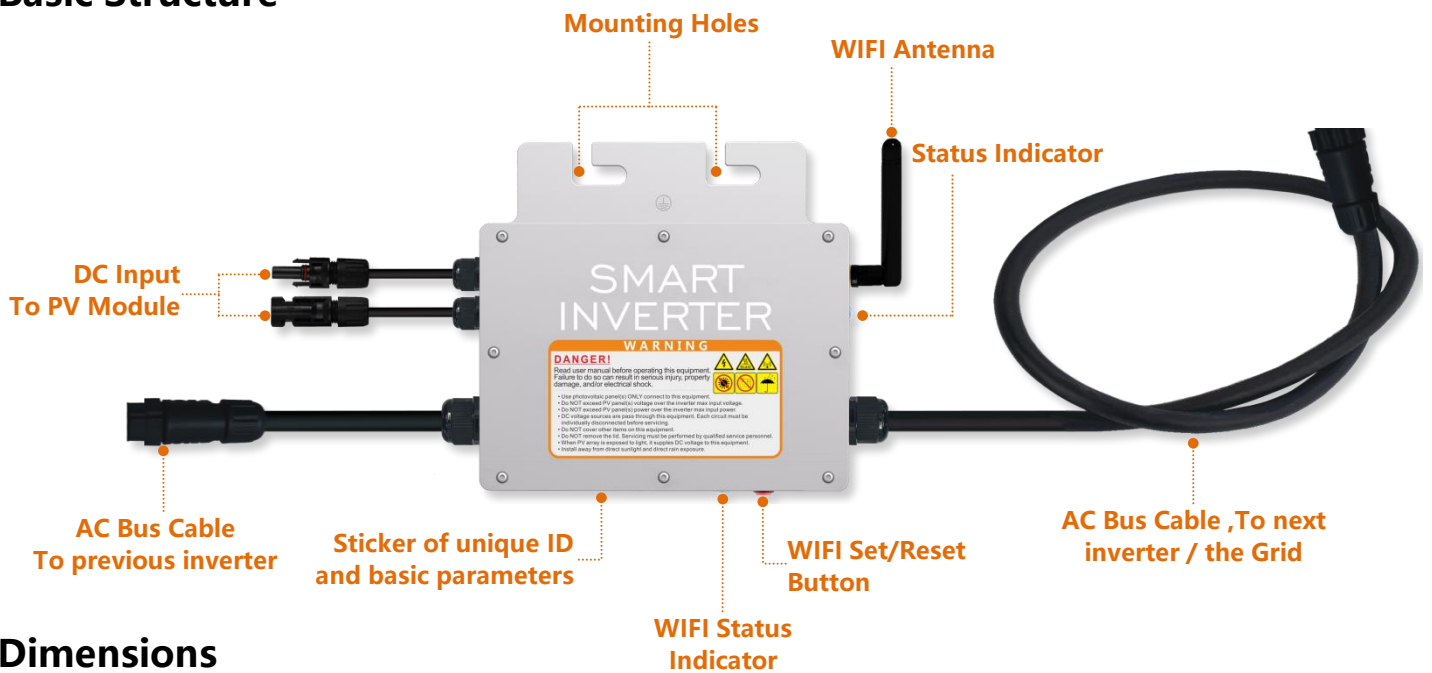

Dimensions

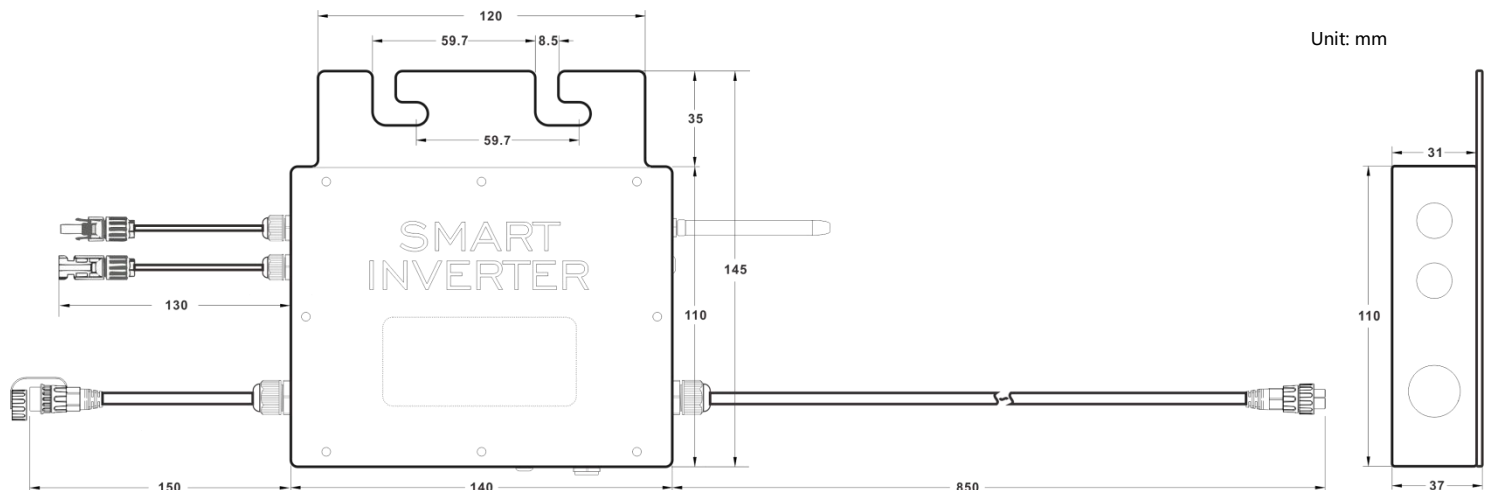

SG500 Series PV Smart Microinverter - Parameter Table

Product Series	SG500 Series
Model	SG500MS (Regular)
Input Data(DC,PV)	
Number of Input MC4 Connector	1 set
MPPT Voltage Range	28V-55V
Operation Voltage Range	20V-60V
Maximum Input Voltage	60V
Startup Voltage	20V
Maximum Input Power	500W
Maximum Input Current	16.66A
Output Data(AC)	
Single-Phase Grid Type	120V / 230V
Rated Output Power	480W
Maximum Output Power	500W
Nominal Output Current	@120VAC : 4.16A / @230VAC : 2.17A
Nominal Output Voltage	120VAC / 230VAC
Default Output Voltage Range	@120VAC : 80V-160V / @230VAC : 180V-280V
Nominal Output Frequency	50Hz & 60Hz
Default Output Frequency Range	@50Hz : 47.5Hz-52.5Hz & @60Hz : 57.5Hz-62.5Hz
Power Factor	>0.99
Total Harmonic Distortion	THD <5%
Maximum Units per Branch	@120VAC : 4 units / @230VAC : 9 units
Efficiency	
Peak Efficiency	95%
CEC Weighted Efficiency	@120VAC : 92.5% / @230VAC : 93.5%
Nominal MPPT Efficiency	99.9%
Night Power Consumption	<700mW
Mechanical Data	
Operating Ambient Temperature Range	-40°C to +65°C
Storage Temperature Range	-40°C to +85°C
Dimensions (W x H x D)	145mm x 140mm x 37mm (not include connectors and cable)
Weight	0.8kg
Max Current of AC Bus Cable	20A
Waterproof Grade	IP65
Cooling Mode	Natural Convection - No Fans
Other Features	
Communication	WIFI (Cloud monitoring)
Transformer Design	High Frequency Transformers, Galvanically Isolated
Integrated Ground	Equipment ground is provided by the PE in the AC cable. No additional ground is required.
Protection Functions	Isolated Island Protection, Voltage Protection, Frequency Protection, Temperature Protection, Current Protection, etc.
Design Compliance	CE etc.

**** Specifications subject to change without notice****

Installation Schematic

SG500-120VAC Microinverter

@

Single-Phase 120V

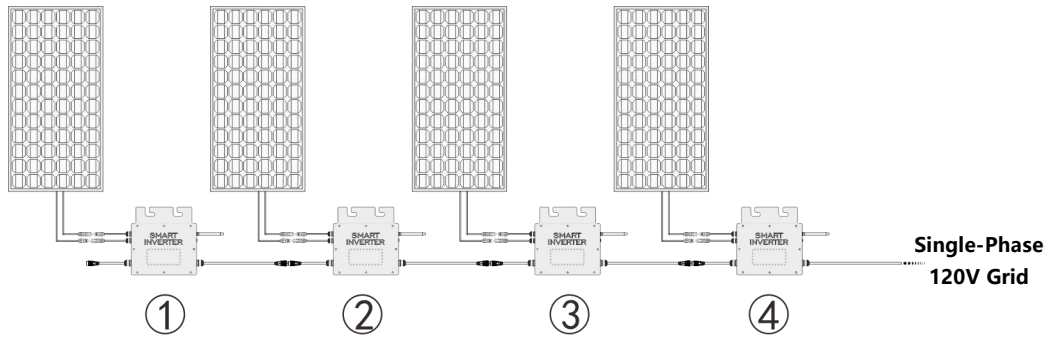

1. SG500-120VAC @Single-Phase 120V grid, Maximum **4** units SG500 Microinverters per branch.
2. The max DC input power of each inverter is **500W** (the PV module max output power is 500W).
3. The **VOC** of PV modules should not be greater than the max DC input voltage of Microinverters.

SG500-230VAC Microinverter

@

2-Phase 208/240V(Single-Phase 120V)

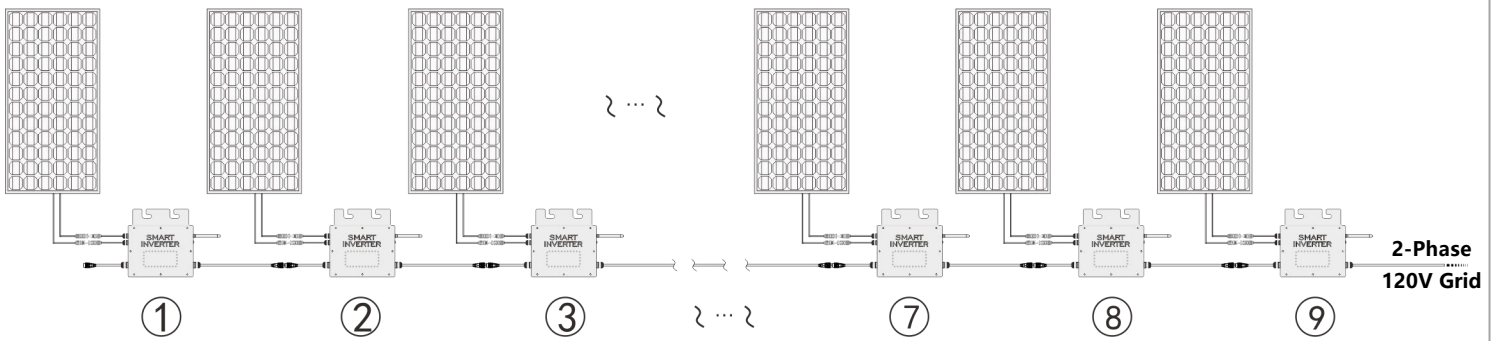

1. SG500-230VAC @2-Phase 208/240V grid, Maximum **9** units SG500 Microinverters per branch.
2. The max DC input power of each inverter is **500W** (the PV module max output power is 500W).
3. The **VOC** of PV modules should not be greater than the max DC input voltage of Microinverters.

SG500-230VAC Microinverter

@

Single-Phase 230V

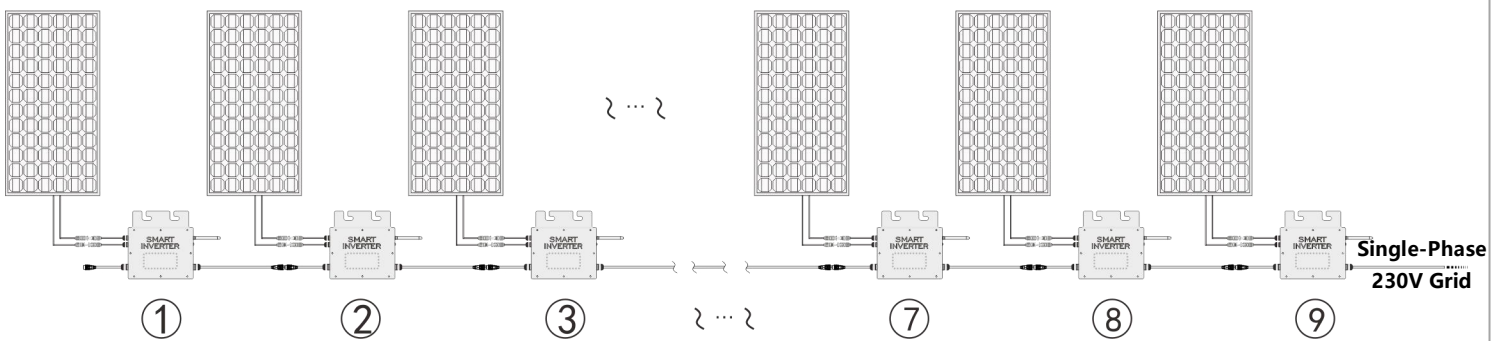

1. SG500-230VAC @Single-Phase 230V grid, Maximum **9** units SG500 Microinverters per branch.
2. The max DC input power of each inverter is **500W** (the PV module max output power is 500W).
3. The **VOC** of PV modules should not be greater than the max DC input voltage of Microinverters.

Wiring Schematic

SG500-230VAC Microinverter

@

Single-Phase 230V

Micro Inverter Voltage	230VAC
Grid Voltage	230V
Grid Type	Single Phase

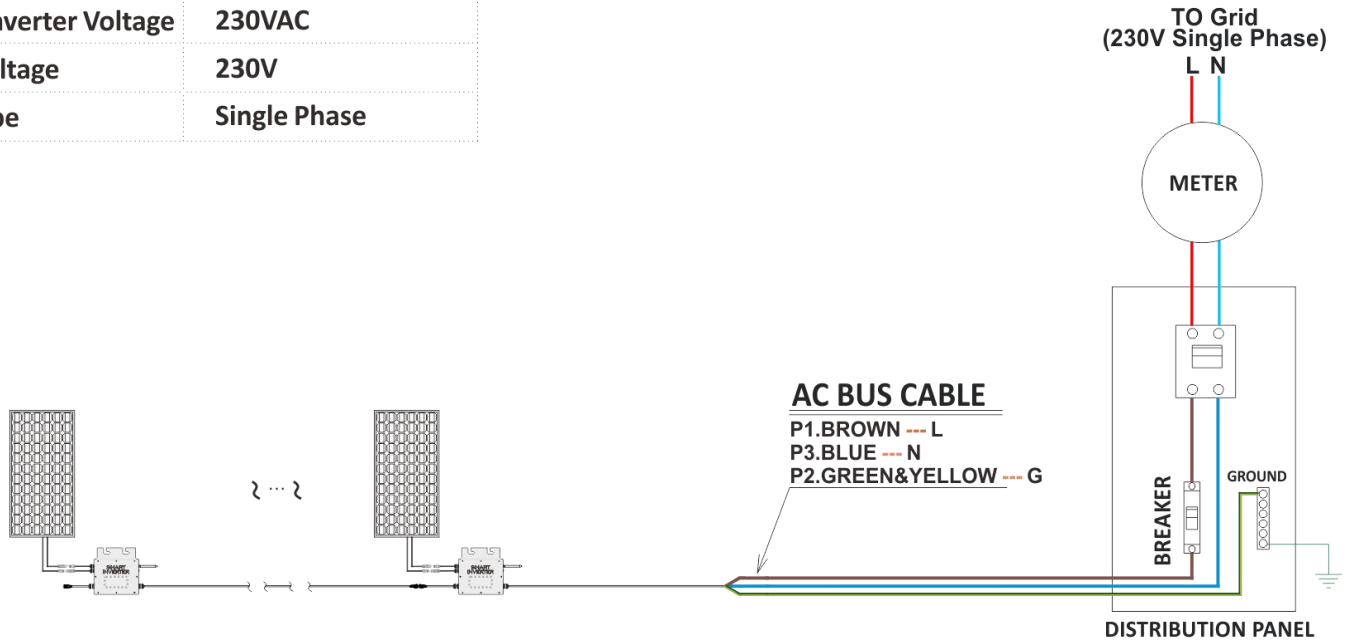

SG500-120VAC Microinverter

@

Single-Phase 120V

Micro Inverter Voltage	120VAC
Grid Voltage	120V
Grid Type	Single Phase

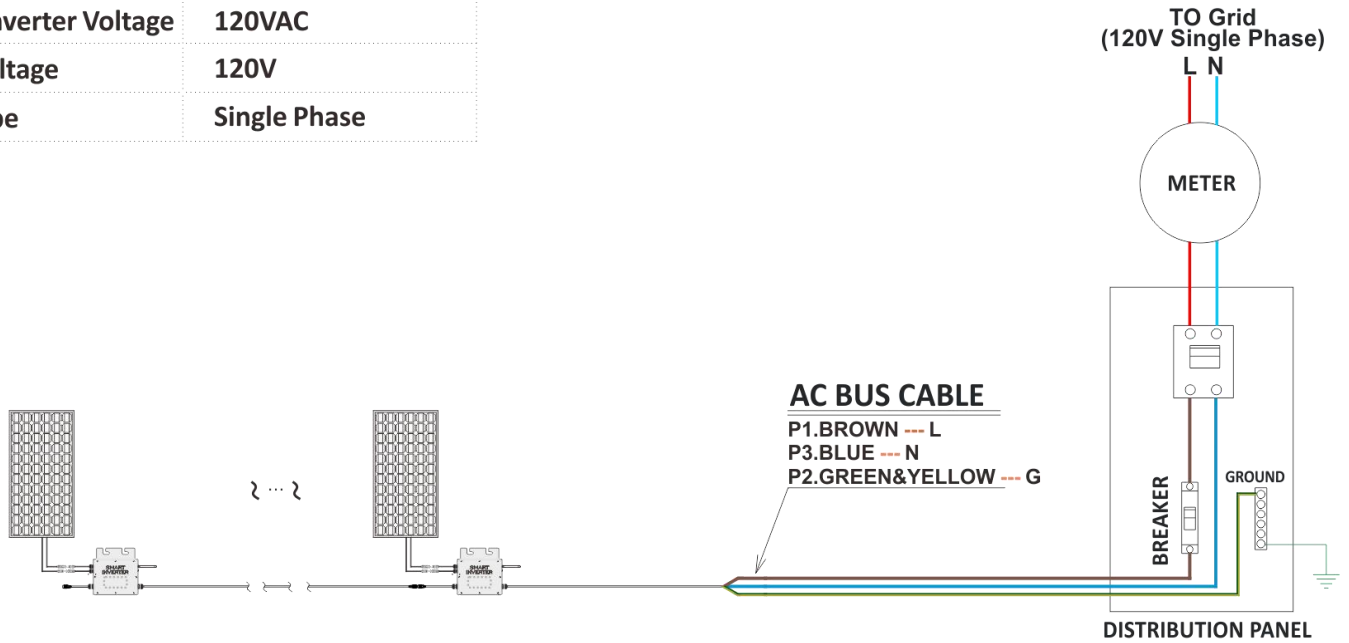

SG500-230VAC Microinverter

@

2-Phase 208/240V(Single-Phase 120V)

Micro Inverter Voltage	230VAC
Grid Voltage	208/240V
Grid Type	Dual Phase

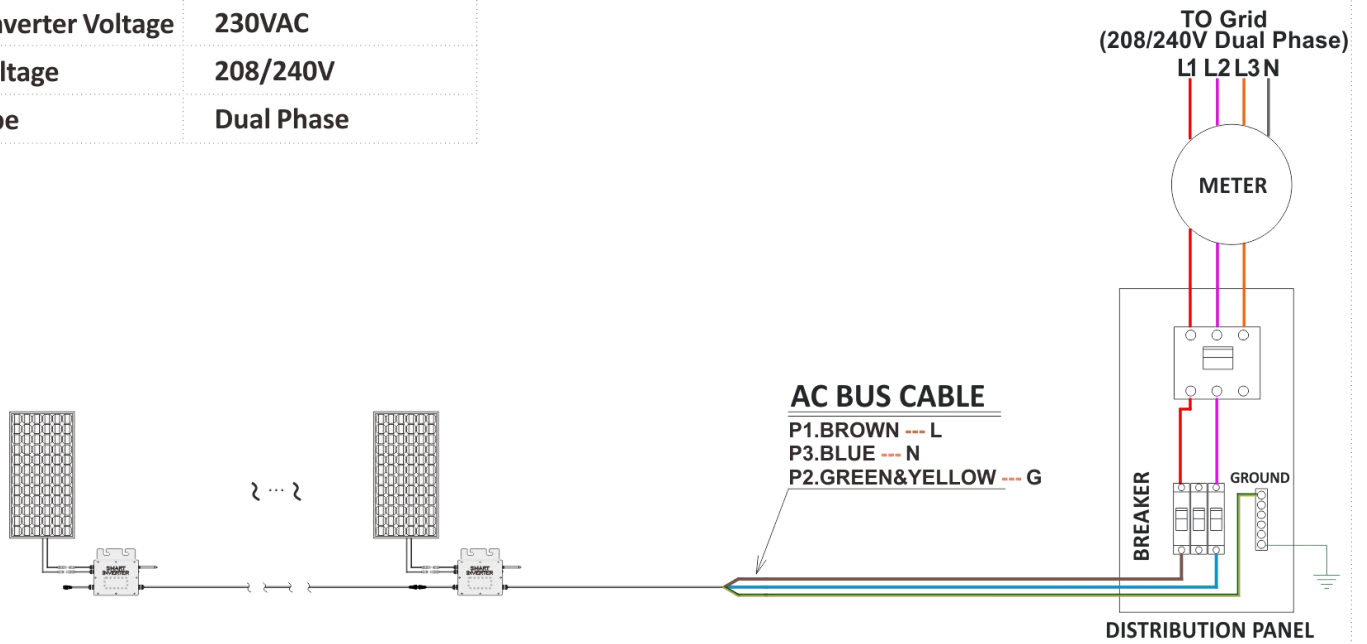

SG500-230VAC Microinverter

@

3-Phase 380V(Single-Phase 230V)

Micro Inverter Voltage	230VAC
Grid Voltage	380V
Grid Type	Triple Phase

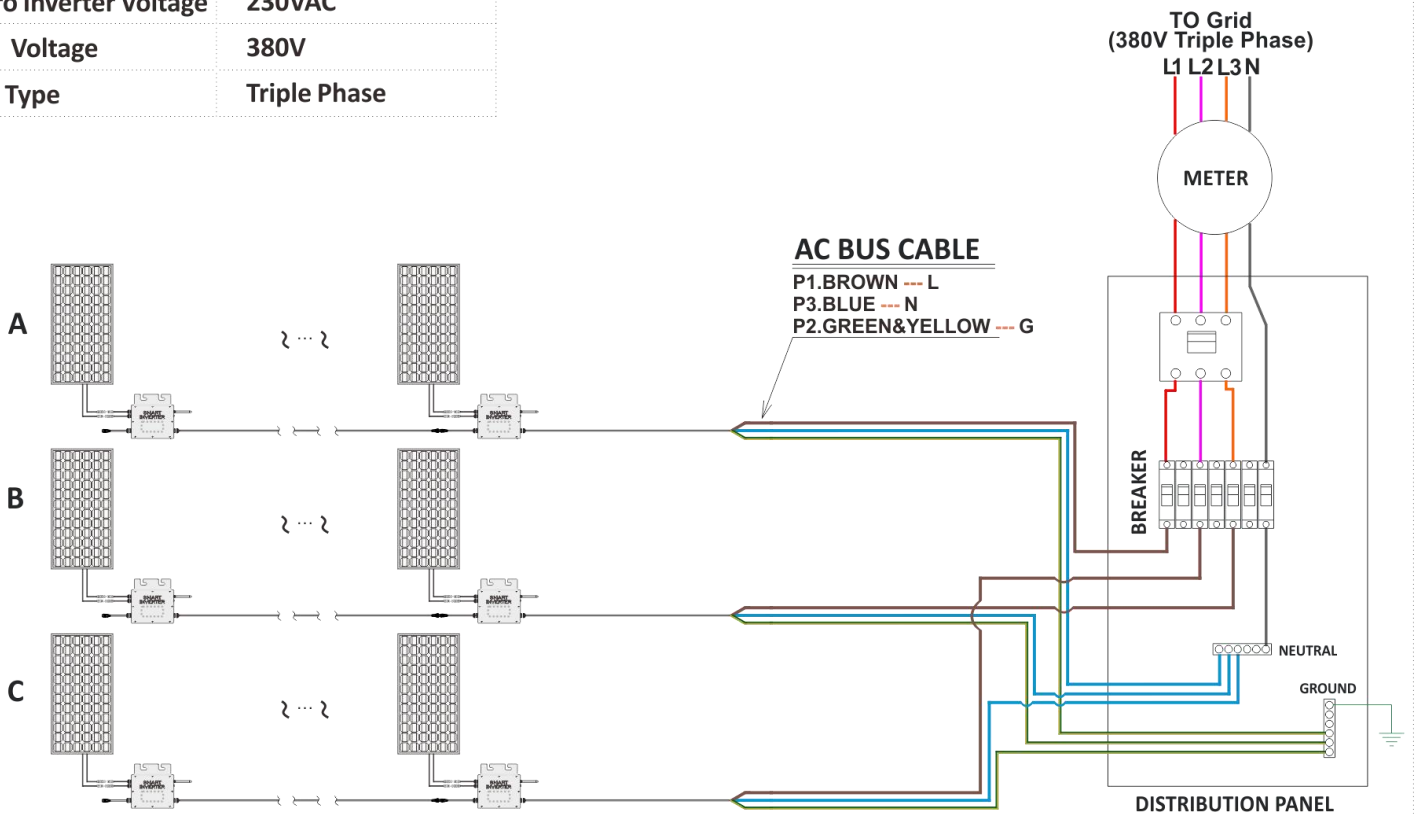

SG500-120VAC Microinverter

@

3-Phase 208/240V(Single-Phase 120V)

Micro Inverter Voltage	120VAC
Grid Voltage	208/240V
Grid Type	Triple Phase

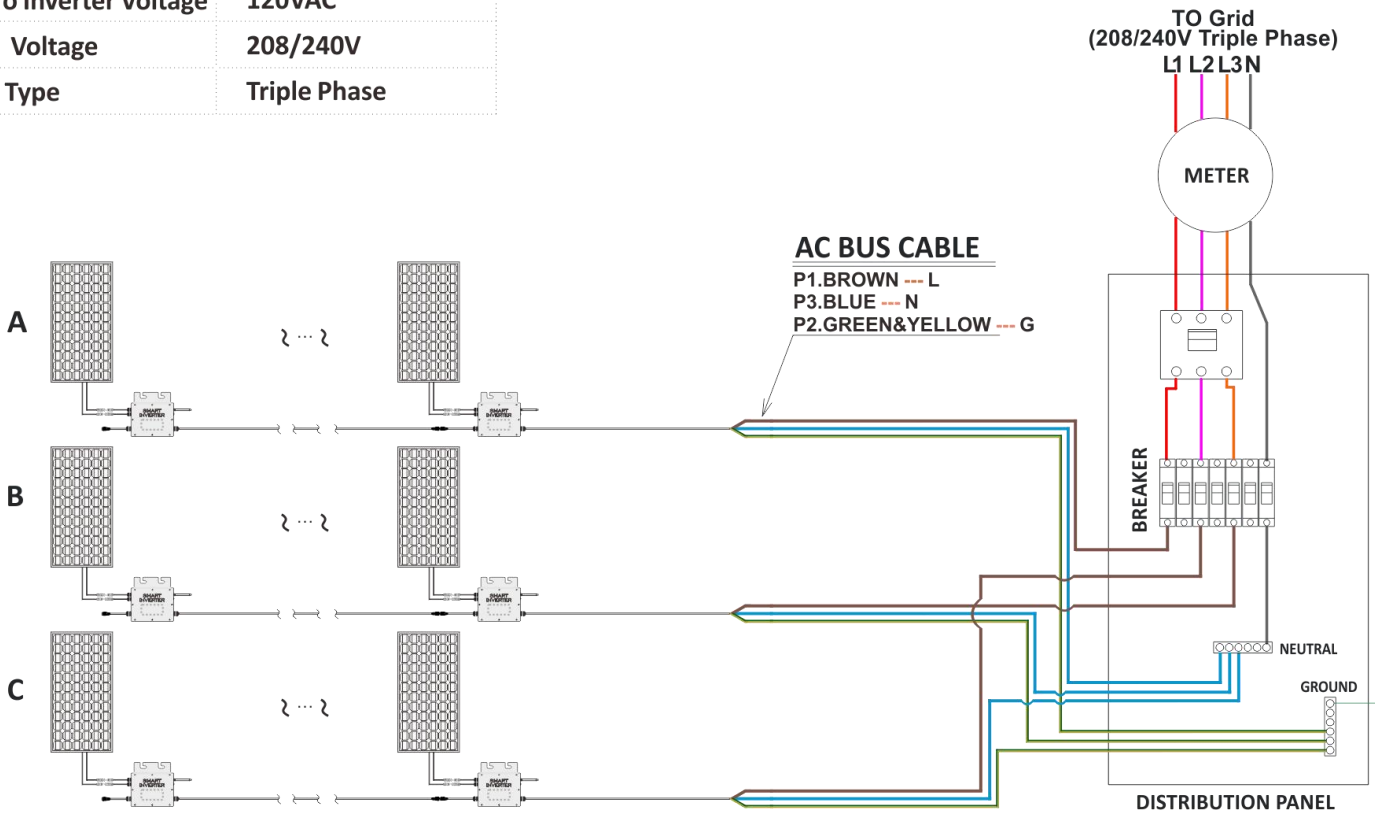

SG500-230VAC Microinverter

@

3-Phase 208/240V(Single-Phase 120V)

Micro Inverter Voltage	230VAC
Grid Voltage	208/240V
Grid Type	Triple Phase

